



## RCA MANUFACTURING COMPANY, INC.

A RADIO CORPORATION OF AMERICA SUBSIDIARY

*Harrison, New Jersey*

RCA RADIOTRON  
D I V I S I O N

APPLICATION NOTE NO. 69  
February 3, 1937.

### APPLICATION NOTE ON 250-VOLT, LOW-CURRENT OPERATION OF THE 6L6

A 6L6 can furnish high power output at small high-order distortion because of its high plate-circuit efficiency, low screen dissipation, and ability to handle high plate currents. These features distinguish the 6L6 from previous output-tube types. However, high plate-current operation of the 6L6 is not essential for good plate-circuit efficiency. This Note discusses the characteristics of new 250-volt operating conditions for the 6L6 in which the bias on the 6L6 is adjusted to produce the same cathode current as a 6F6.

#### Single-Tube Operation: Fixed Bias and Zero Power-Supply Regulation

An ideal operating condition for an output tube obtains when the electrode voltages do not vary with power output. This ideal condition cannot be met in practice because some plate, screen, and bias regulation is always present. However, it is desirable to know the ideal operating characteristics of a tube in order to compare actual performance with ideal performance and to know what can be expected from a tube under the most favorable operating conditions.

Two of the three curves of Fig. 1 show the variation in power output and harmonic distortion at the grid-current points vs. load resistance for a single 6L6 under the following conditions: plate voltage, 250 volts; screen voltage, 250 volts; grid bias, -21 volts; no-signal cathode current, 40.5 milliamperes; zero grid-bias regulation; and zero power-supply regulation. These conditions produce the same no-signal cathode current for a 6L6 and a 6F6. The relation between power output at 7 per cent distortion and load resistance was determined and is also shown in Fig. 1. A load resistance of 7000 ohms was selected.

Fig. 2 shows the variation in distortion, rms signal voltage, and cathode current vs. power output for the 6L6 and 6F6. The 6L6 can furnish nearly 5.5 watts at the grid-current point and 3.5 watts at 7 per cent distortion.

#### Single-Tube Operation: Self-Bias with Regulation

The performance of the 6L6 was determined for a practical operating condition. The control-grid voltage was obtained from a self-bias resistor; plate and screen voltages were obtained from a power supply having an in-

Copyright, 1937 by  
RCA Manufacturing Co., Inc.

ANR-69-1-19-37  
Printed in U.S.A.

*RCA Cunningham • Radiotron Radio Tubes • RCA Radiotron Transmitting Tubes • Special Purpose Tubes • Photo Tubes • Cathode Ray Tubes  
Genuine RCA Replacement Parts, Accessories and Test Equipment*

A P P L I C A T I O N N O T E S



ternal resistance of 1000 ohms. The no-signal B-supply voltage in this test was adjusted to 266.5 volts. This is the value required for self-biased 250-volt operation of a 6F6. The self-bias resistor of the 6L6 was adjusted to produce a cathode current of 40.5 milliamperes, the cathode current of a 6F6 with -16.5 volts bias and 250 volts on plate and screen. Under these conditions, the no-signal plate voltage and the no-signal screen voltage of the 6L6 are approximately 246 volts.

The relation between power output at the grid-current point and distortion vs. load resistance of a 6L6 is shown by two curves in Fig. 3; the third curve shows the relation between power output at 7 per cent distortion and load resistance. These data indicate that a load resistance of 7000 ohms is desirable. For this operating condition, the 6L6 furnishes approximately 4.5 watts at the grid-current point, as shown in Fig. 4. The cathode resistor was by-passed with a large condenser in order to minimize the effects of de-generation at 420 cycles, the test frequency.

#### Single-Tube Operation in a Radio Receiver

A third test on the operation of a single 6L6 at low cathode current was conducted in a radio receiver of average design. The audio amplifier originally consisted of a 6F5 resistance-coupled to a 6F6. Each a-f tube was self-biased; each self-bias resistor was by-passed with a 12  $\mu$ f electrolytic condenser. Curves of distortion, rms input signal to the 6F5, and cathode current of the 6F6 vs. power output were taken. A 6L6 was substituted for the 6F6 and the bias resistor of the output tube was changed from 410 ohms to 515 ohms. The distortion, input signal, and cathode-current curves were repeated for this tube type. The data for the 6L6 and 6F6 are shown in Fig. 5.

In this average receiver, more than 4 watts can be obtained from either tube type. The cathode currents of both tube types for the same power output are very nearly equal. Because more output without grid current can be obtained from a 6L6 than from a 6F6, the output of the 6L6 contains less high-order distortion, even though the total-distortion characteristics of both tube types are nearly alike.

#### Push-Pull Operation: Fixed Bias and Zero Power-Supply Regulation

The series of tests described for single-tube operation were repeated for the push-pull connection. Three test conditions were used: (1) fixed bias and zero power-supply regulation; (2) self-bias and power-supply regulation due to internal resistance of 1000 ohms; and (3) operation in a radio receiver of average design.

From the power-output and distortion curves of Fig. 6, it appears that plate-to-plate load resistances from 5000 to 7000 ohms are satisfactory. The solid-line curves of Fig. 7 show total distortion, rms signal voltage, and cathode current vs. power output for two type 6L6 tubes connected in push-pull. The three sets of solid-line curves correspond to plate-to-plate loads of 5000, 6000, and 7000 ohms. These curves show that two 6L6's can furnish approximately 14 watts under these conditions.

Push-Pull Operation: Self-Bias with Regulation

The power output value of 14 watts in the preceding paragraph cannot be realized when the power supply has regulation and the control-grid voltage is obtained from a self-bias resistor. Therefore, it is desirable to know what can be obtained under representative conditions. Curves of power output and distortion vs. plate-to-plate load for self-bias operation from a power supply having an internal resistance of 1000 ohms are shown in Fig. 8. At the grid-current point, over 11 watts at 2 per cent distortion can be obtained. The cathode resistor was by-passed with a very large condenser (60  $\mu$ f) in this test in order to show only the effects of self-bias and power-supply regulation.

Curves of cathode current, rms signal input, and distortion vs. power output for push-pull operation under practical conditions are shown in Fig. 9. The two sets of solid-line curves, which obtain for the 6L6, show the effect of decreasing the value of the cathode by-pass condenser from a very high value (above 60  $\mu$ f) to 8  $\mu$ f. The removal of this by-pass condenser caused a rise in distortion to 15 per cent at the grid-current point. These curves show that the power output is not reduced when the value of this condenser is changed. The curves were not carried into the grid-current region, because the effect of grid current on distortion depends on the nature of the grid circuit.

Push-Pull Operation in a Radio Receiver

A final test on the push-pull operation of the type 6L6 tube at reduced cathode current was conducted in a radio receiver of average design. The a-f amplifier section of this receiver is shown schematically in Fig. 11. The output of a two-tube phase inverter feeds two type 6F6's connected in push-pull. The output tubes are self-biased, the cathode resistor is by-passed with a 10  $\mu$ f condenser, and the internal resistance of the power supply is 1600 ohms. A 420-cycle test signal was introduced at the grid of the 6Q7. Output voltage was measured across the primary of the receiver's output transformer; output power is the power delivered to the output transformer.

The curves of Fig. 10 show the variations in cathode current and total distortion vs. power output. With the proper cathode resistor and plate-to-plate load, the 6L6's can furnish 10.5 watts at 4.2 per cent distortion.

Typical Low-Current Operating Conditions

Typical conditions for low-current operation of the 6L6 are as follows:

	<u>Single 6L6</u>	<u>Push-Pull 6L6's</u>	
Heater Voltage	6.3	6.3	Volts
B-Supply Voltage	266.5	266.5	Volts
Cathode Current	40.5	81	Milliamperes
Load Resistance	7000	7000*	Ohms
Self-Bias Resistor	515	257	Ohms
Internal Resistance of Power Supply	1000	1000	Ohms
Power Output at Grid-Current Point	4.5	11	Watts

\*Plate to plate





SINGLE-TUBE OPERATION CHARACTERISTICS  
FIXED BIAS

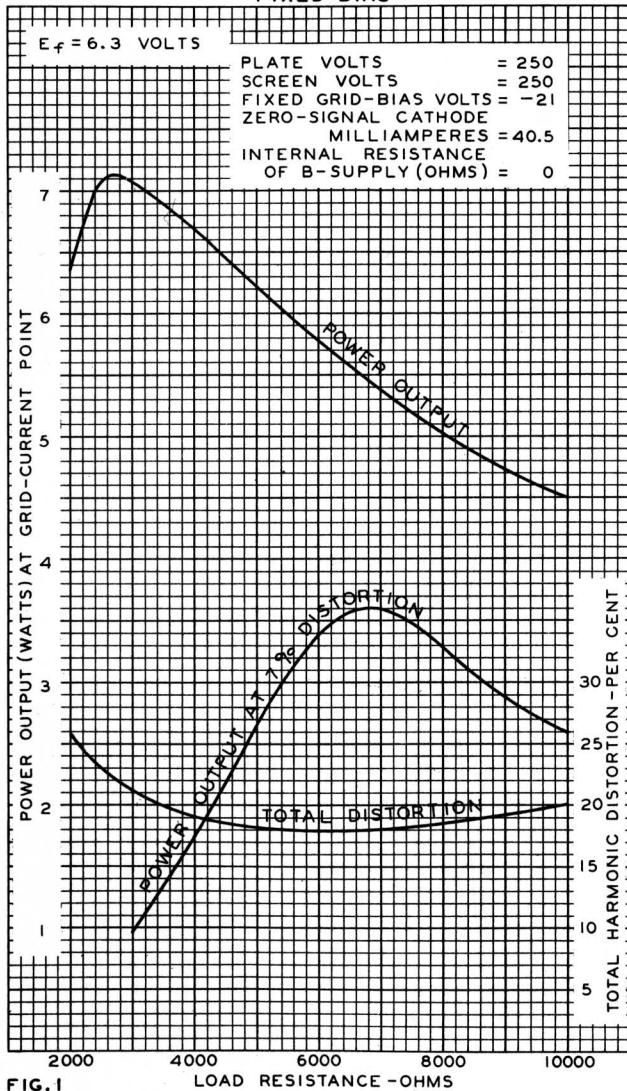

FIG. 1

DEC. 23, 1936

RCA RADIOTRON DIVISION  
RCA MANUFACTURING COMPANY, INC.

92C-4703



SINGLE-TUBE OPERATION CHARACTERISTICS  
FIXED BIAS

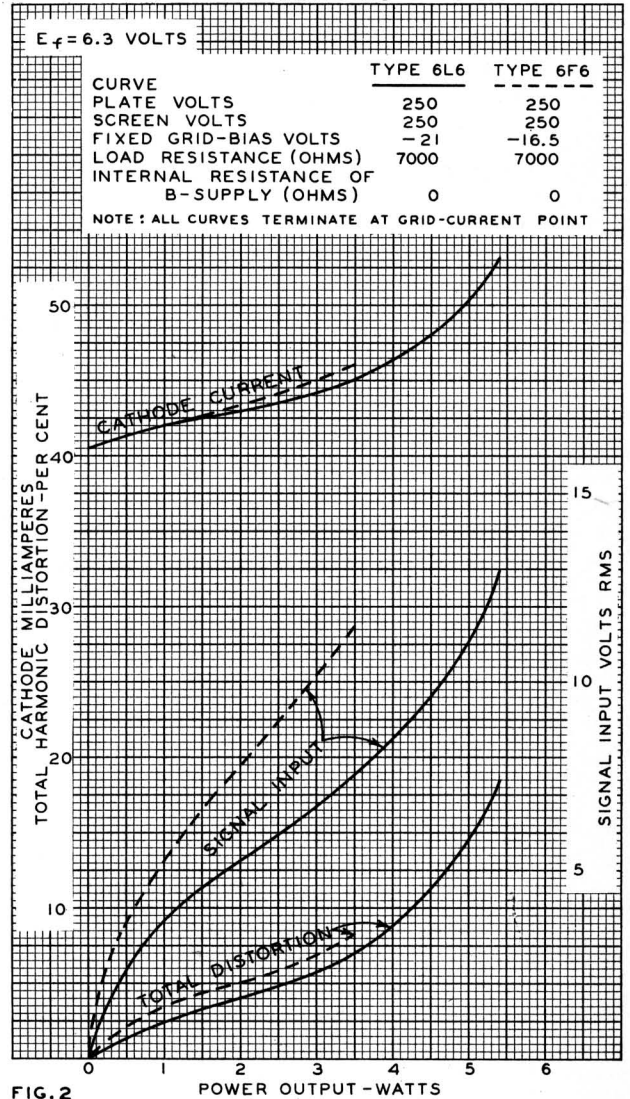

FIG. 2

DEC. 23, 1936

RCA RADIOTRON DIVISION  
RCA MANUFACTURING COMPANY, INC.

92C-4704



RCA-6L6

SINGLE-TUBE OPERATION CHARACTERISTICS  
SELF-BIAS

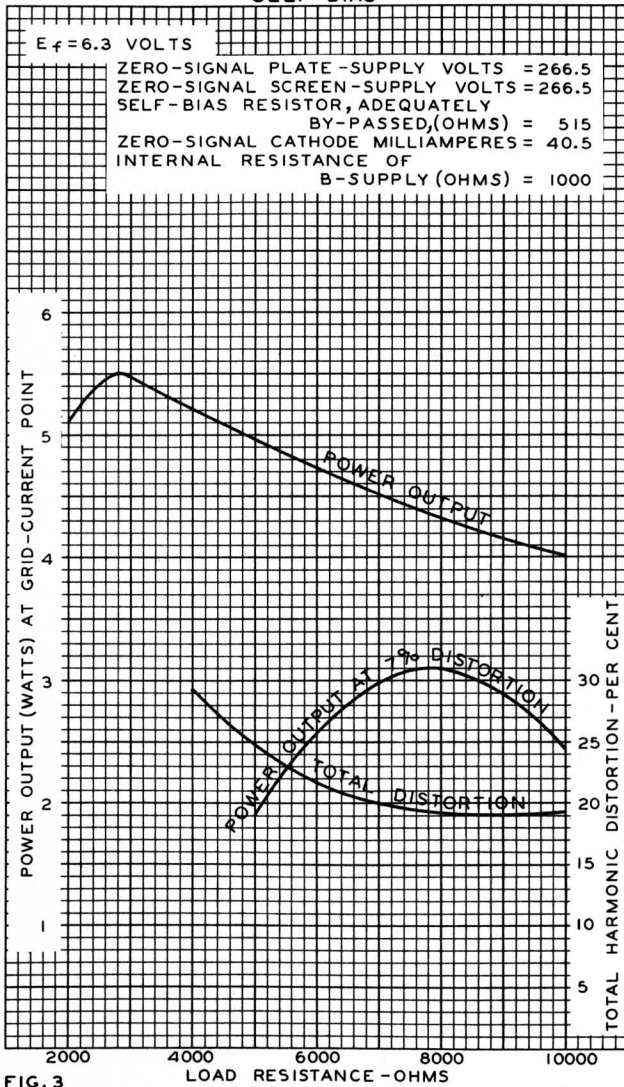

FIG. 3

DEC. 30, 1936

RCA RADIOTRON DIVISION  
RCA MANUFACTURING COMPANY, INC.

92C-4705



RCA-6L6, RCA-6F6

SINGLE-TUBE OPERATION CHARACTERISTICS  
SELF-BIAS

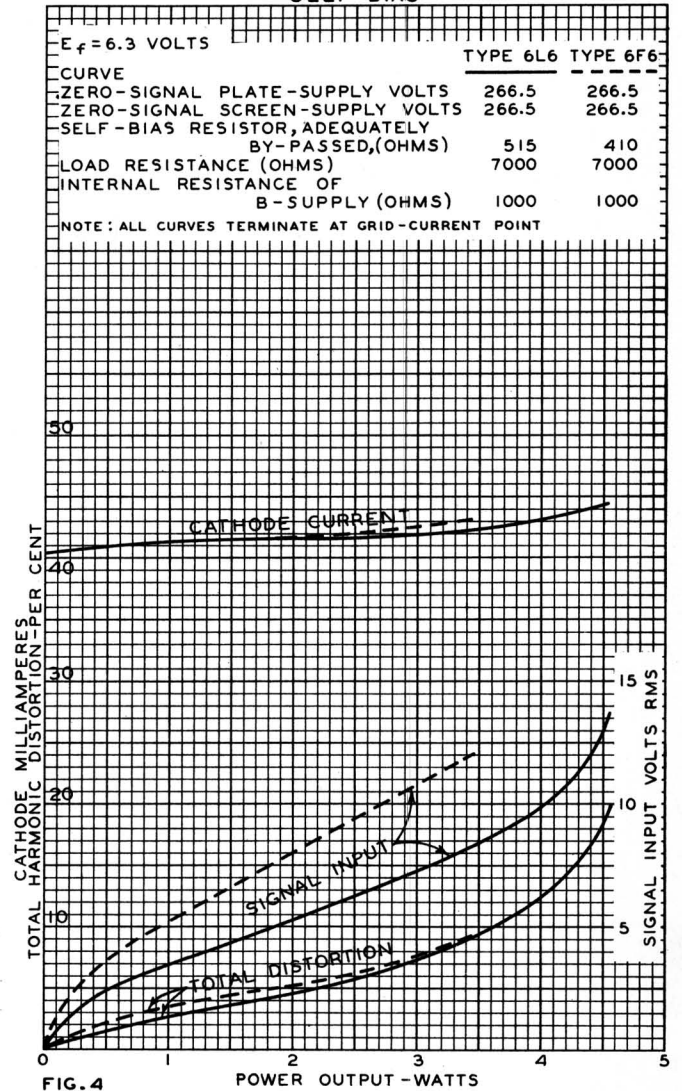

FIG. 4

DEC. 30, 1936

RCA RADIOTRON DIVISION  
RCA MANUFACTURING COMPANY, INC.

92C-4706



RCA-6L6, RCA-6F6

SINGLE-TUBE OPERATION CHARACTERISTICS OF 6L6 AND 6F6 IN AN AVERAGE RECEIVER

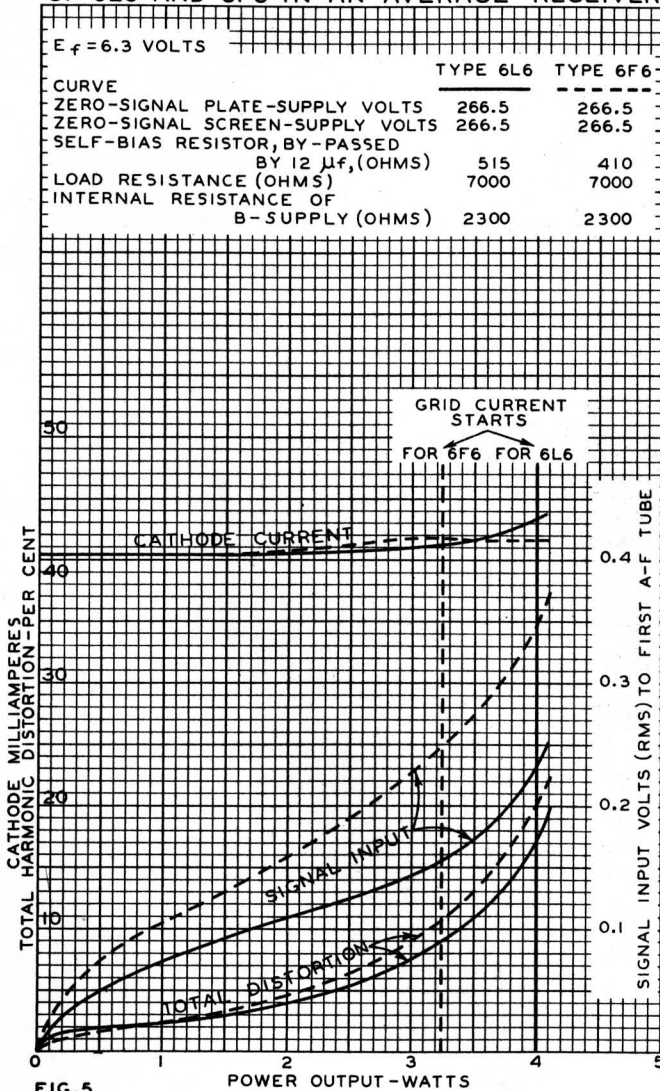

FIG. 5

JAN. 4, 1937

RCA RADIOTRON DIVISION  
RCA MANUFACTURING COMPANY, INC.

92C-4710



RCA-6L6

PUSH-PULL OPERATION CHARACTERISTICS FIXED BIAS

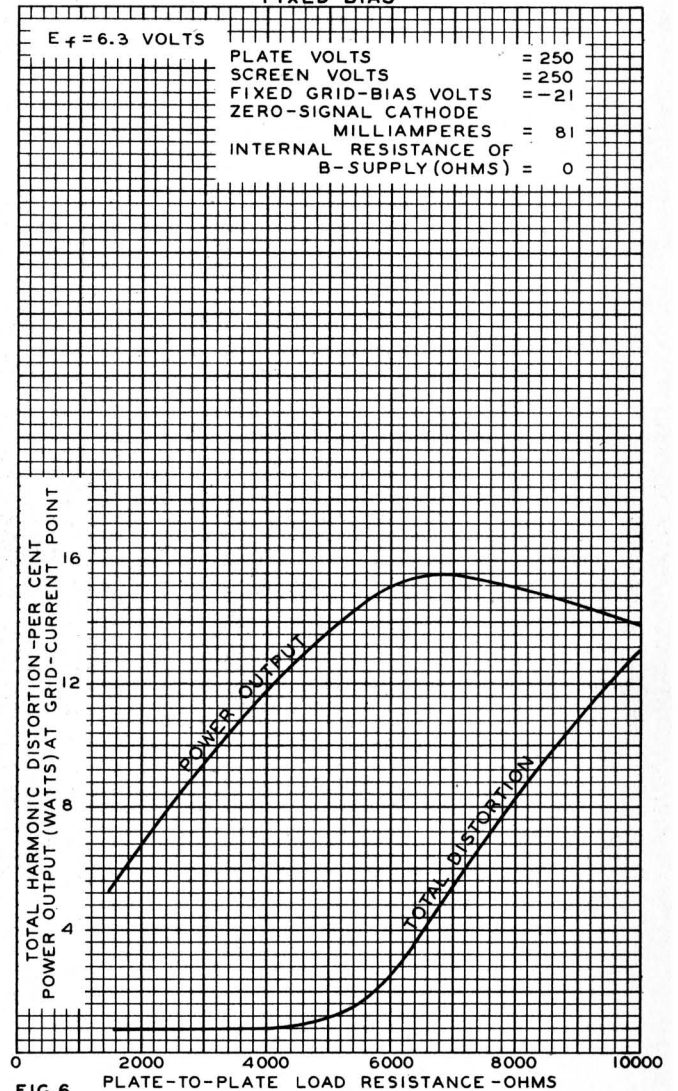

FIG. 6

JAN. 4, 1937

RCA RADIOTRON DIVISION  
RCA MANUFACTURING COMPANY, INC.

92C-4711



RCA-6L6, RCA-6F6

PUSH-PULL OPERATION CHARACTERISTICS  
FIXED BIAS

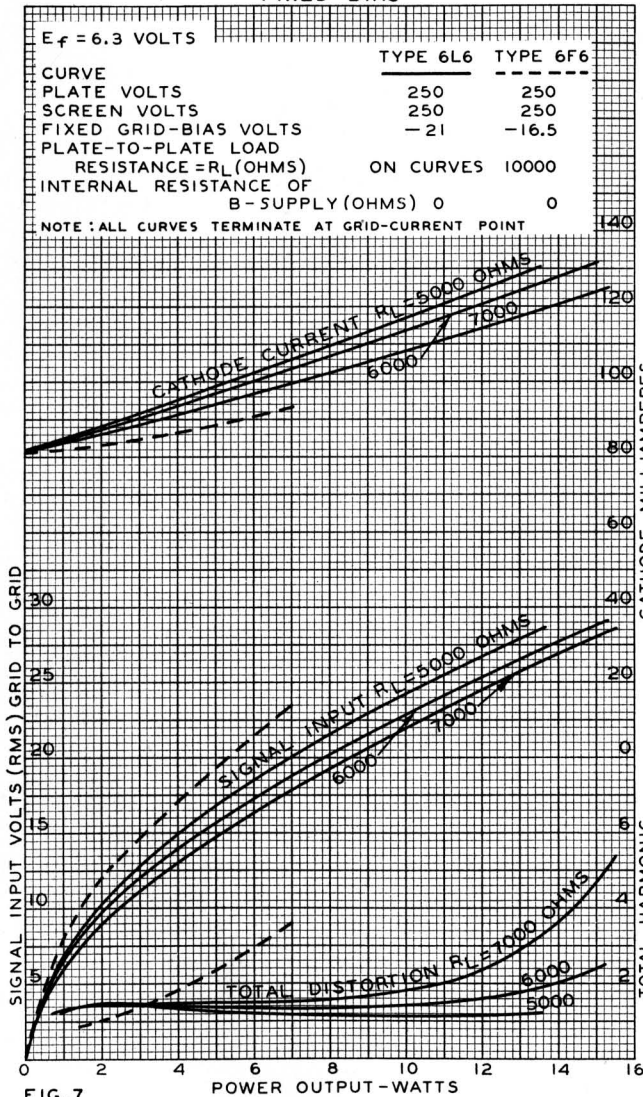

FIG. 7

JAN. 7, 1937

RCA RADIOTRON DIVISION  
RCA MANUFACTURING COMPANY, INC.

92C-4712



RCA-6L6

PUSH-PULL OPERATION CHARACTERISTICS  
SELF-BIAS

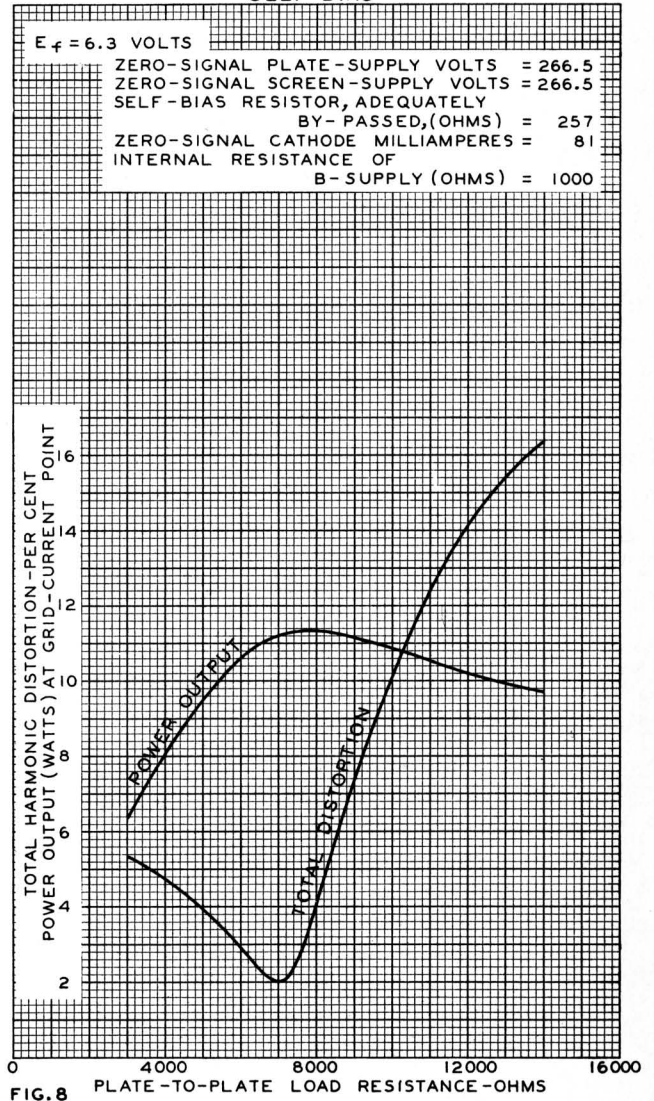

FIG. 8

JAN. 7, 1937

RCA RADIOTRON DIVISION  
RCA MANUFACTURING COMPANY, INC.

92C-4713





RCA-6L6, RCA-6F6

PUSH-PULL OPERATION CHARACTERISTICS  
SELF-BIAS

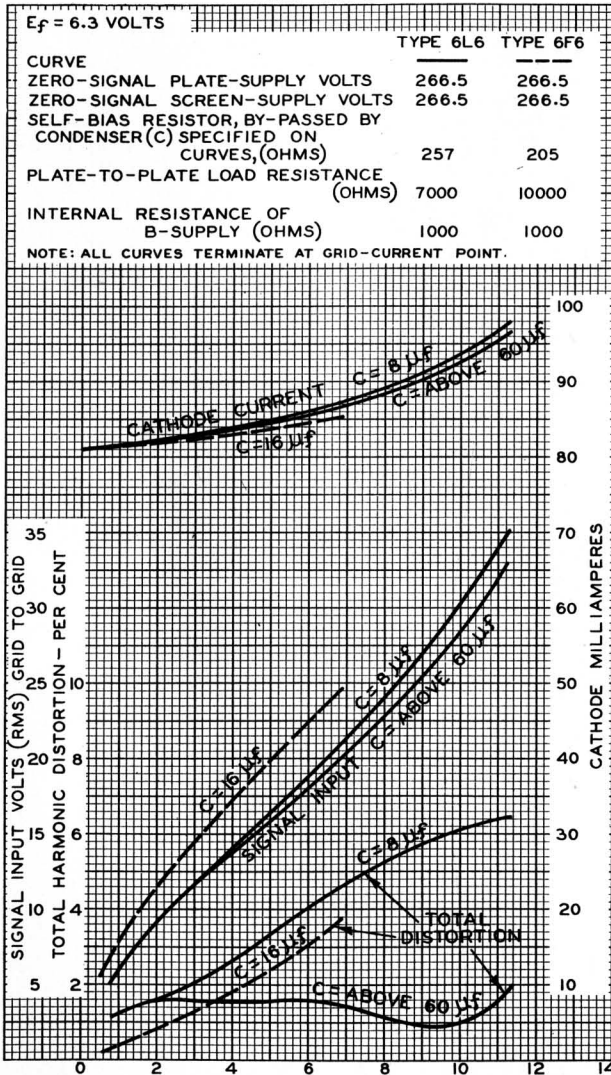

FIG. 9

JAN. 4, 1937

RCA RADIOTRON DIVISION  
RCA MANUFACTURING COMPANY, INC.

92C-4708



RCA-6L6, RCA-6F6

PUSH-PULL OPERATION CHARACTERISTICS  
OF 6L6'S AND 6F6'S IN AN AVERAGE RECEIVER

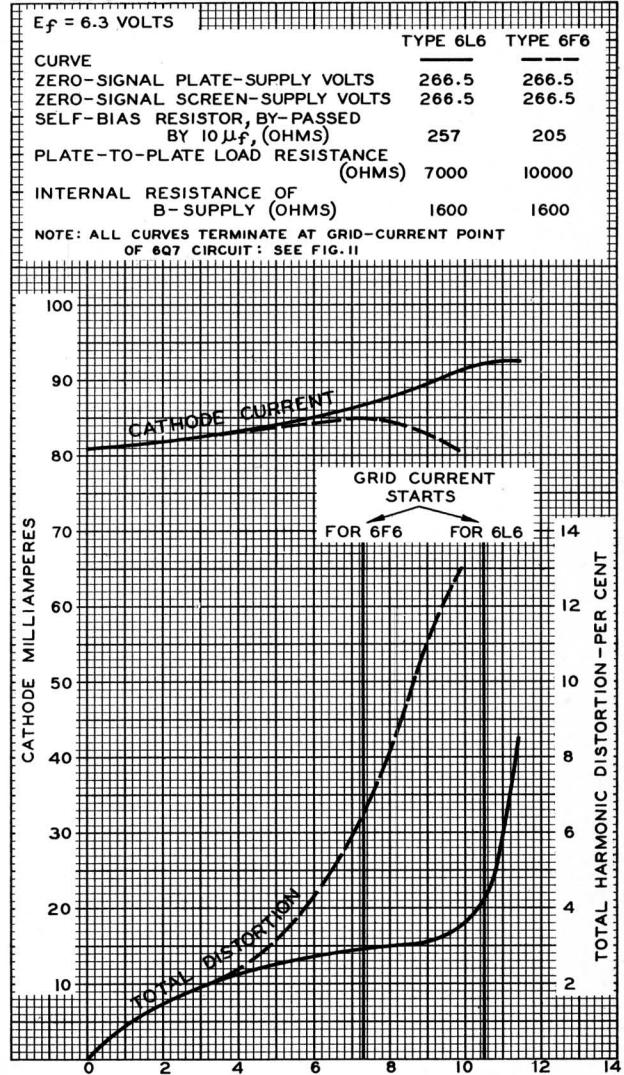

FIG. 10

JAN. 4, 1937

RCA RADIOTRON DIVISION  
RCA MANUFACTURING COMPANY, INC.

92C-4709



RECEIVER CIRCUIT USED FOR DETERMINATION OF 6L6 CHARACTERISTICS SHOWN IN FIG. 10

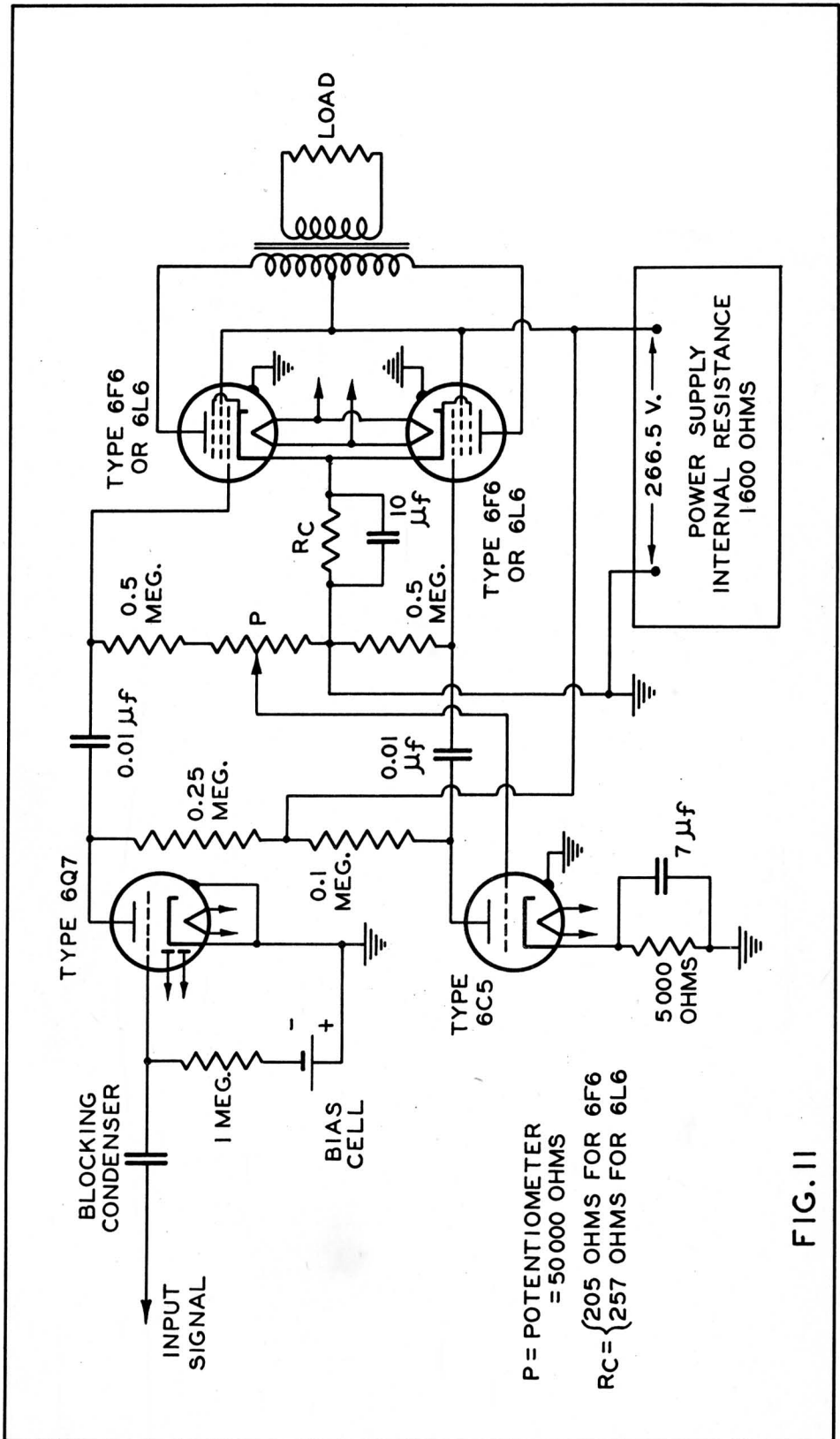

FIG. 11

The license extended to the purchaser of tubes appears in the License Notice accompanying them. Information contained herein is furnished without assuming any obligations.